

1

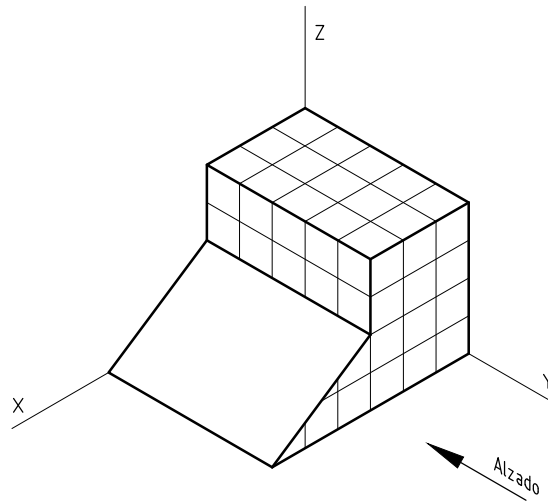

Obtener las seis vistas de la pieza representada en dibujo isométrico.

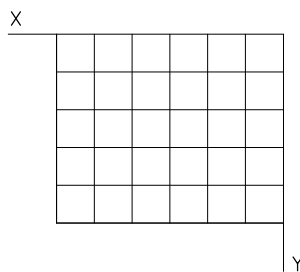
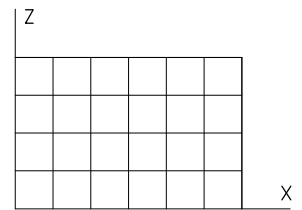
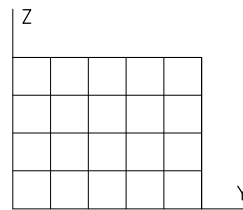
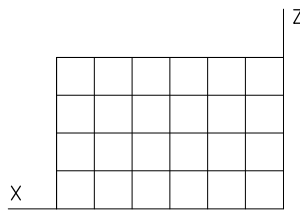
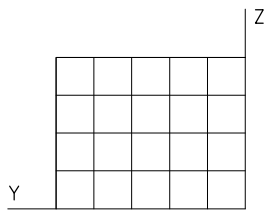
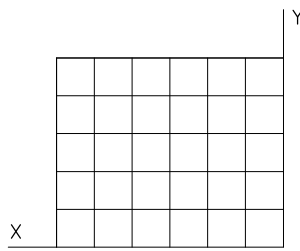

Nombre:

Curso:

Nº

Escala  
1 / 1

Obtención de vistas

Fecha:

Lámina E-3